



Cambridge International Examinations
Cambridge International General Certificate of Secondary Education

PHYSICS

0625/21

Paper 2 Multiple Choice (Extended)

May/June 2017

45 minutes

Additional Materials: Multiple Choice Answer Sheet
Soft clean eraser
Soft pencil (type B or HB recommended)

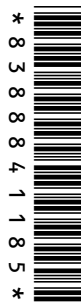

READ THESE INSTRUCTIONS FIRST

Write in soft pencil.

Do not use staples, paper clips, glue or correction fluid.

Write your name, Centre number and candidate number on the Answer Sheet in the spaces provided unless this has been done for you.

DO NOT WRITE IN ANY BARCODES.

There are **forty** questions on this paper. Answer **all** questions. For each question there are four possible answers **A, B, C** and **D**.

Choose the **one** you consider correct and record your choice in **soft pencil** on the separate Answer Sheet.

Read the instructions on the Answer Sheet very carefully.

Each correct answer will score one mark. A mark will not be deducted for a wrong answer.

Any rough working should be done in this booklet.

Electronic calculators may be used.

Take the weight of 1.0 kg to be 10 N (acceleration of free fall = 10 m/s^2).

The syllabus is approved for use in England, Wales and Northern Ireland as a Cambridge International Level 1/Level 2 Certificate.

This document consists of **18** printed pages and **2** blank pages.

- 1 What is the most accurate and precise method to measure the thickness of a coin?
- A Use a micrometer screw gauge.
 - B Use a ruler and look at the scale perpendicularly.
 - C Use a top pan balance.
 - D Use the displacement method with water in a measuring cylinder.
- 2 On Earth, a ball is dropped and falls 2.0 m in a vacuum.

The acceleration of the ball at 1.0 m is 10 m/s^2 .

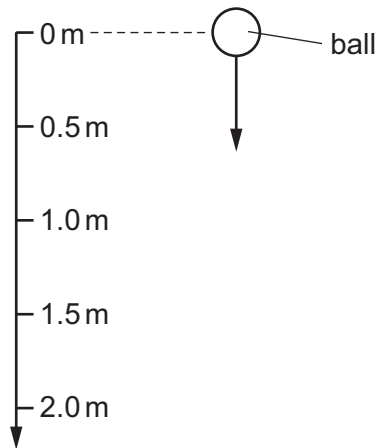

What is the acceleration of the ball at 0.5 m?

- A 5.0 m/s^2
 - B 10 m/s^2
 - C 15 m/s^2
 - D 20 m/s^2
- 3 A skydiver reaches terminal velocity. Then he opens his parachute.
- What happens to the skydiver as the parachute opens?
- A There is a decrease in weight.
 - B There is acceleration upwards.
 - C There is an increase in speed.
 - D There is movement upwards.

- 4 A piece of steel is taken from the Earth to the Moon for an experiment. The gravitational field strength on the Moon is smaller than on the Earth.

Which statement about the piece of steel is correct?

- A It has less mass on the Moon than on the Earth.
 B It has more mass on the Moon than on the Earth.
 C It weighs less on the Moon than on the Earth.
 D It weighs more on the Moon than on the Earth.
- 5 A measuring cylinder containing only water is placed on an electronic balance. A small, irregularly shaped stone is now completely immersed in the water.

The diagrams show the equipment before and after the stone is immersed.

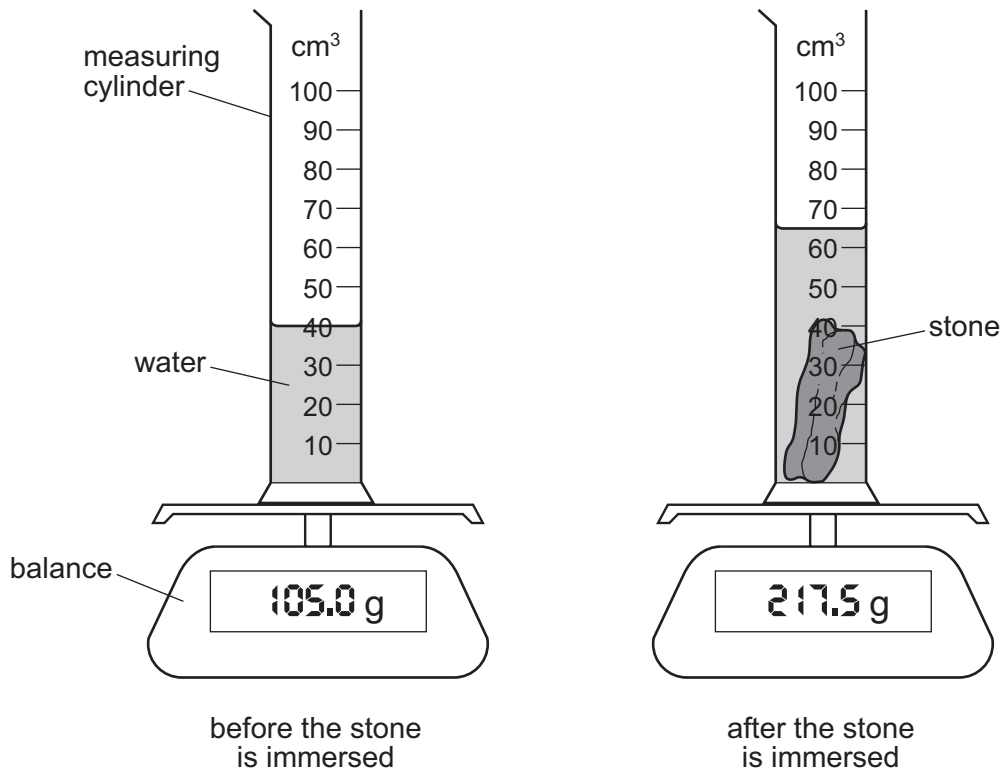

What is the density of the material of the stone?

- A 1.7 g/cm³ B 3.3 g/cm³ C 4.5 g/cm³ D 8.7 g/cm³

6 A boat is travelling at a steady speed in a straight line across the surface of a lake.

Which statement about the boat is correct?

- A The resultant force on the boat is in the direction of motion.
- B The resultant force on the boat is in the opposite direction to its motion.
- C The resultant force on the boat is vertically downwards.
- D The resultant force on the boat is zero.

7 A ball of weight 1.2 N drops through the air at terminal velocity.

A sudden gust of wind exerts a horizontal force of 0.5 N on the ball from the left.

Which diagram shows the resultant force on the ball while the wind is blowing?

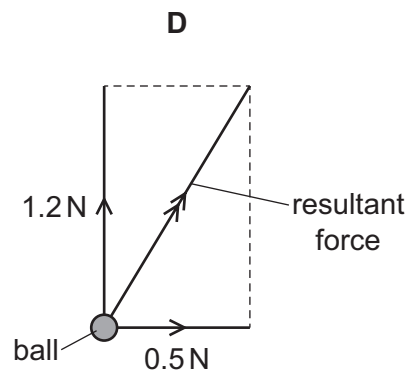
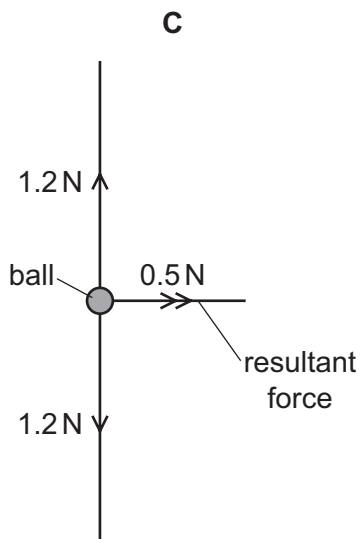
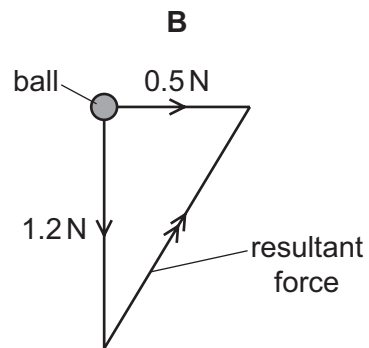
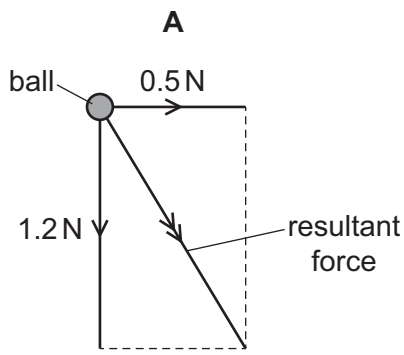

- 8 The diagram shows a uniform bridge, 4.0 m long and weighing 10 000 N.

The bridge is pivoted at one end. A force at the other end gradually increases until the bridge begins to lift.

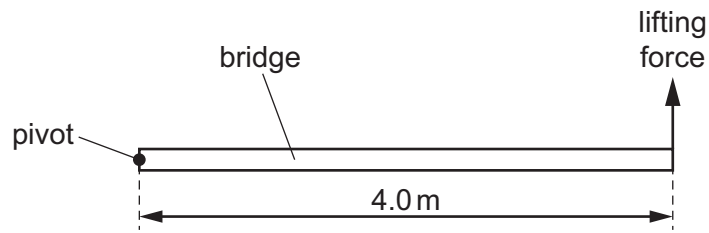

What is the lifting force as the bridge starts to move upwards?

- A** 2500 N **B** 5000 N **C** 10 000 N **D** 20 000 N
- 9 A bullet of mass 0.10 kg travels horizontally at a speed of 600 m/s. It strikes a stationary wooden block of mass 1.90 kg resting on a frictionless, horizontal surface.

The bullet stays in the block.

What is the speed of the bullet and the block immediately after the impact?

- A** 30 m/s **B** 32 m/s **C** 60 m/s **D** 134 m/s

- 10 A box of mass m slides down a slope of length l and vertical height d against a frictional force F .

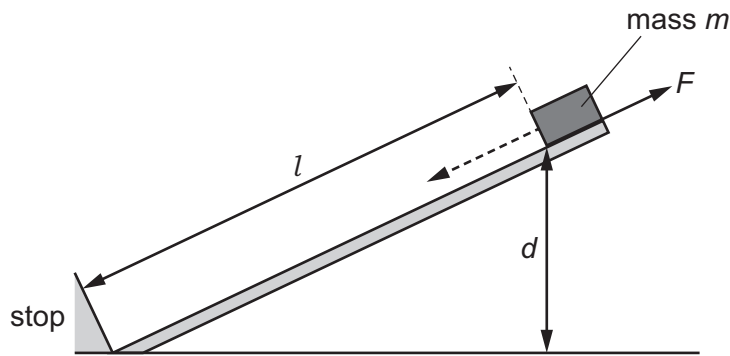

As the box slides down the slope, it loses gravitational potential energy and it does work against the friction.

Which row gives the loss in gravitational potential energy and the work done against friction?

	loss in gravitational potential energy	work done against friction
A	mgd	Fl
B	mgd	Fd
C	mgl	Fl
D	mgl	Fd

- 11 The diagram represents the energy transfers for a device.

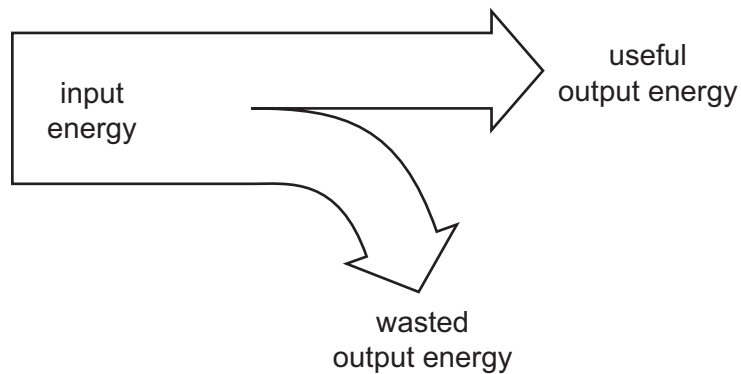

The device is 50% efficient.

Which equation is correct?

- A** input energy = useful output energy \div 2
B useful output energy = wasted output energy \div 2
C wasted output energy = useful output energy
D wasted output energy = useful output energy \div 2

12 A student carries out some simple exercises.

In which exercise is the most work done?

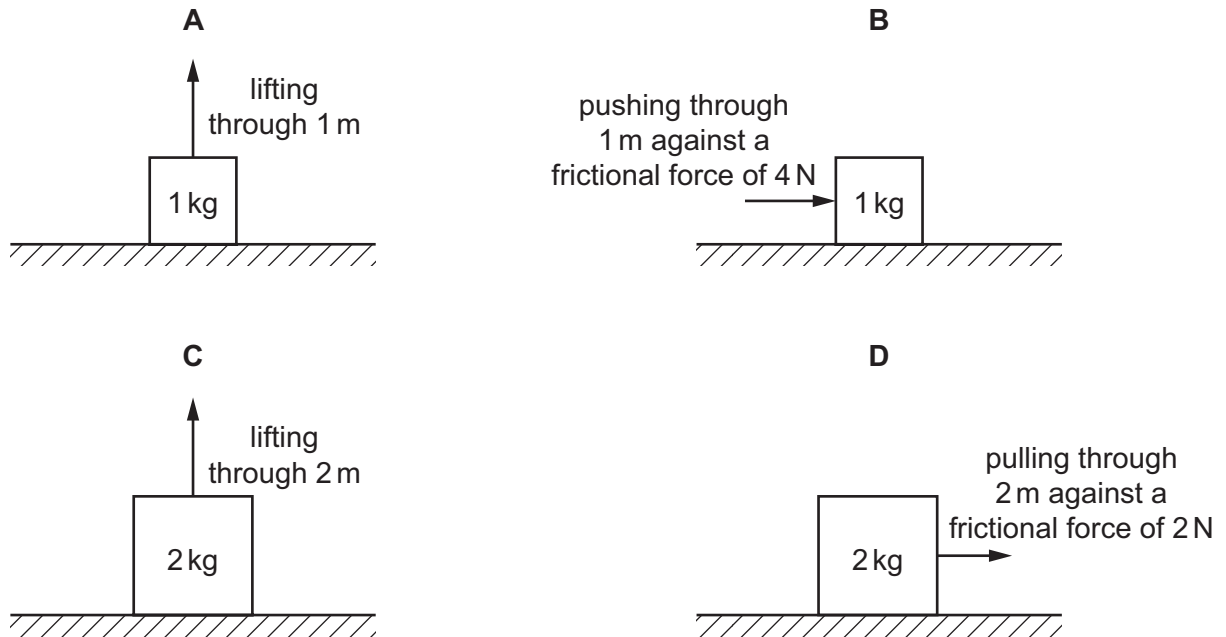

13 Four different liquids are poured into four containers.

The diagrams show the depth and the density of liquid in each container.

In which container is the pressure on its base the greatest?

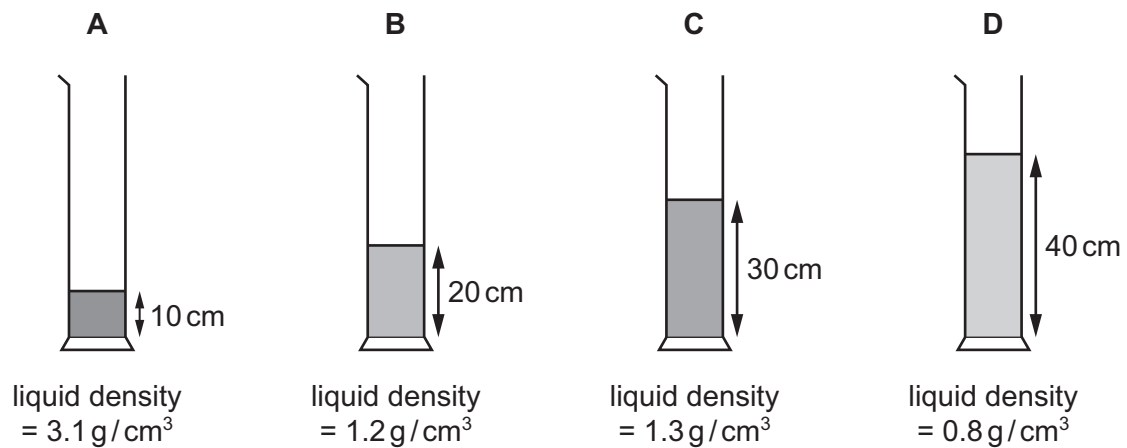

14 Brownian motion is observed when using a microscope to look at smoke particles in air.

What causes the smoke particles to move at random?

- A** Smoke particles are hit by air molecules.
- B** Smoke particles are moved by convection currents in the air.
- C** Smoke particles have different weights and fall at different speeds.
- D** Smoke particles hit the walls of the container.

15 Gas molecules striking a container wall cause a pressure to be exerted on the wall.

Which statement explains this?

- A** When a molecule rebounds there must be a change in its energy.
- B** When a molecule rebounds there must be a change in its momentum.
- C** When a molecule rebounds there must be a change in its speed.
- D** When a molecule rebounds there must be a change in its temperature.

16 Equal masses of two different liquids are put into identical beakers.

Liquid 1 is heated for 100 s and liquid 2 is heated for 200 s by heaters of the **same power**.

Each liquid has the same rise in temperature.

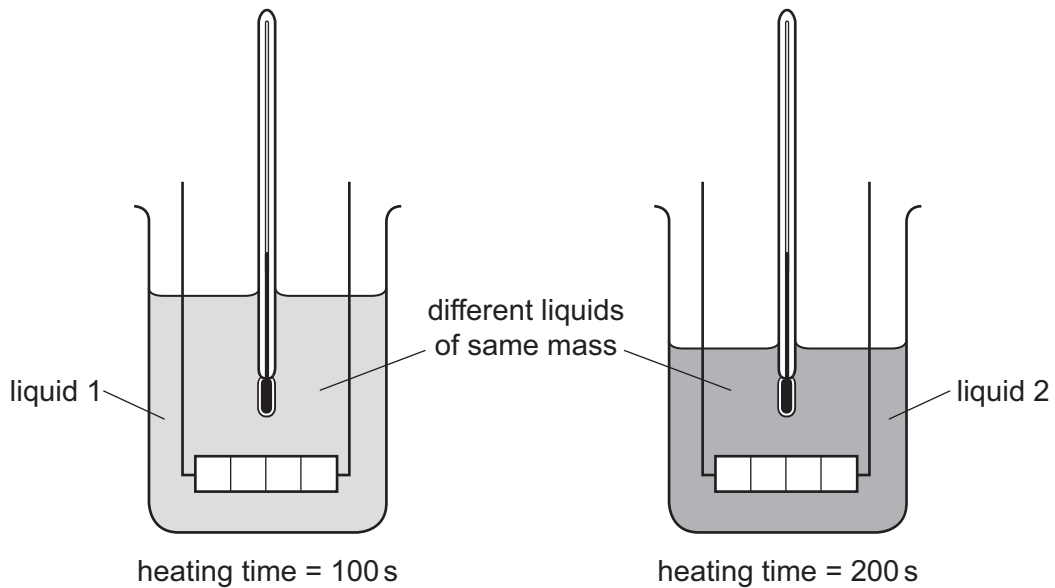

Which statement is correct?

- A Each beaker of liquid has the same thermal capacity.
- B Each beaker of liquid receives the same energy.
- C Liquid 1 receives more energy than liquid 2.
- D The thermal capacity of liquid 1 is less than the thermal capacity of liquid 2.

17 Water of mass 100g at a temperature of 100°C is converted into steam at 100°C. The specific latent heat of vaporisation of water is 2300 J/g.

How much thermal energy is absorbed by the water?

- A 23 J
- B 230 J
- C 230 000 J
- D 23 000 000 J

18 A copper bar and a wooden bar are joined. A piece of paper is wrapped tightly around the join.

The bar is heated strongly at the centre for a short time, and the paper goes brown on one side only.

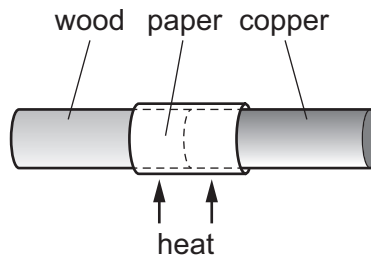

Which side goes brown, and what does this show about wood and copper?

	brown side	wood	copper
A	copper	conductor	insulator
B	copper	insulator	conductor
C	wood	conductor	insulator
D	wood	insulator	conductor

19 Different waves hit barriers with different sized gaps.

The waves will diffract.

In which diagram does the greatest spreading occur?

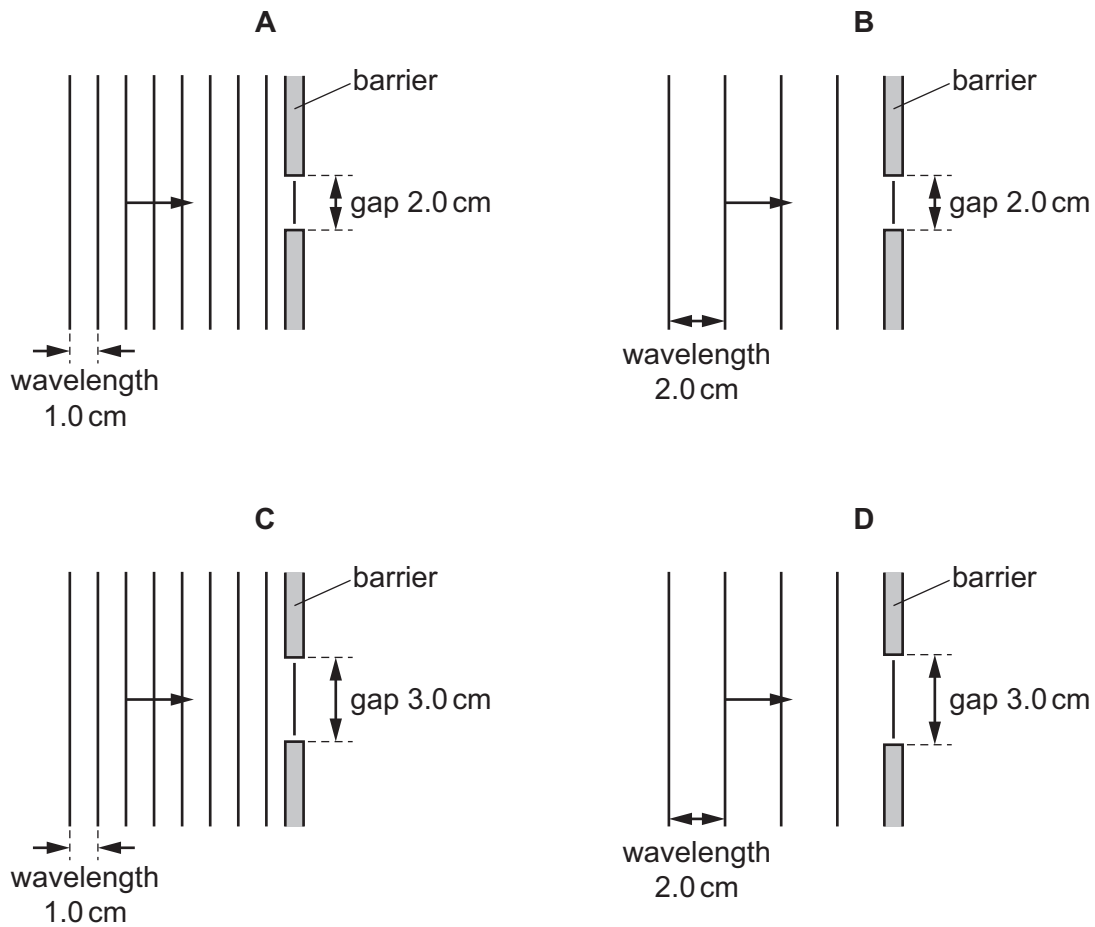

20 A converging lens is used as a magnifying glass to view an object.

Which statement is correct?

- A The image is inverted.
- B The image is nearer the lens than the object.
- C The image is the same size.
- D The image is virtual.

21 Which diagram shows what happens when a ray of white light passes through a prism?

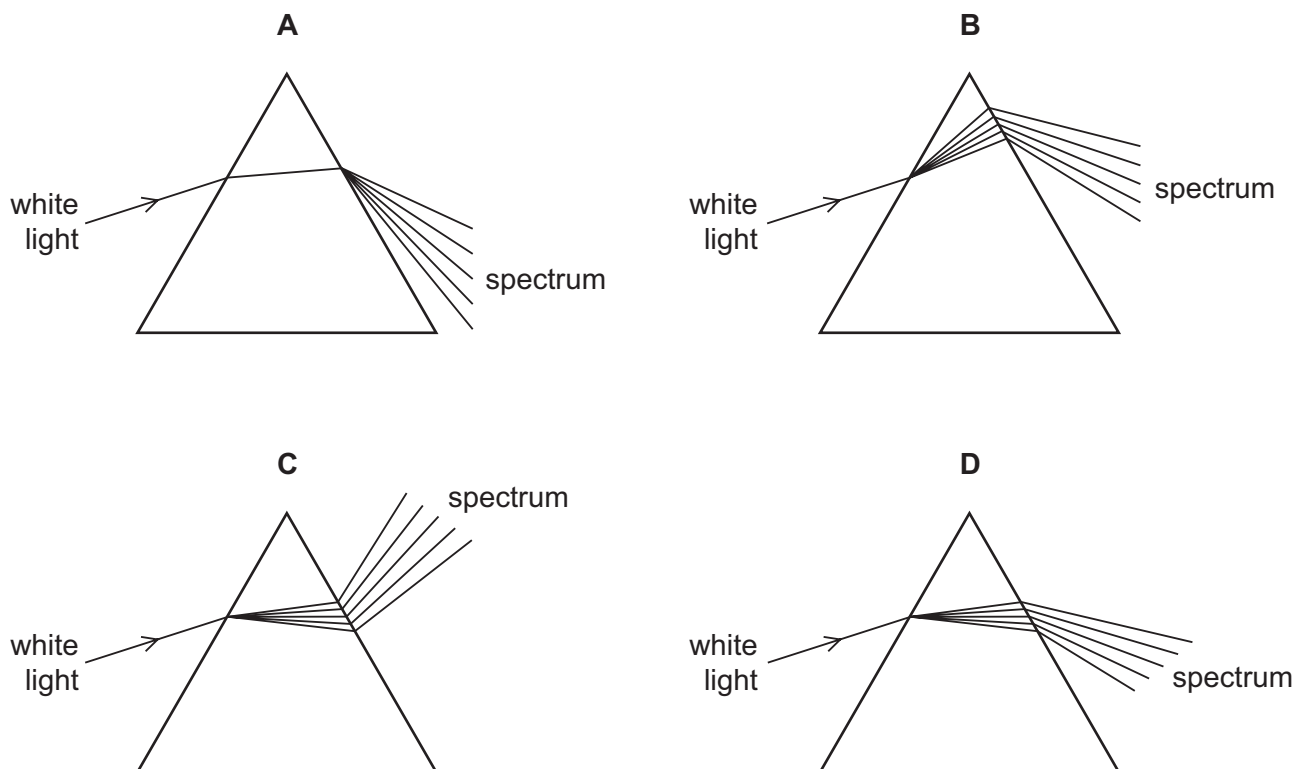

22 Light travels in a vacuum and then enters a glass block. The speed of the light in the glass block is 2.0×10^8 m/s.

Which statement about the speed of light is correct?

- A The speed in a vacuum is 1.5 times the speed in the glass.
 - B The speed in the glass is the same as the speed in a vacuum.
 - C The speed in the glass is 1.5 times the speed in a vacuum.
 - D The speed in the glass is 1.0×10^8 times the speed in a vacuum.
- 23 A fire alarm is not loud enough and the pitch is too low. An engineer adjusts the alarm so that it produces a louder note of a higher pitch.

What effect does this have on the amplitude and on the frequency of the sound?

	amplitude	frequency
A	larger	greater
B	larger	smaller
C	smaller	greater
D	smaller	smaller

- 24 In a child's toy, metal fish are lifted out of a toy pond using a metal rod. The fish are magnetically attracted to the end of the rod. There is no magnetic force between the fish themselves.

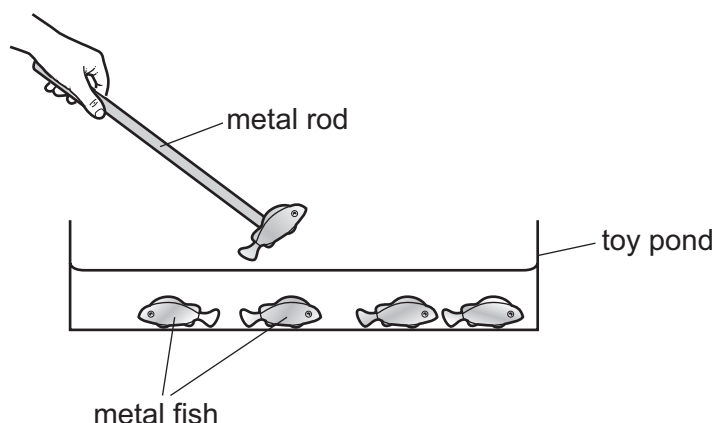

What are possible materials from which the fish and the rod are made?

	fish	rod
A	aluminium	soft iron
B	aluminium	steel
C	soft iron	soft iron
D	soft iron	steel

- 25 What is the most effective method of demagnetising a bar magnet?
- A** placing the magnet in a solenoid carrying a large alternating current and gradually decreasing the current
 - B** placing the magnet in a solenoid carrying a large direct current and gradually decreasing the current
 - C** placing the magnet in a solenoid that produces a magnetic field in the opposite direction to the magnet
 - D** placing the magnet next to an identical bar magnet with its poles in the opposite direction
- 26 A magnet near a coil of wire is attracted to the coil only when there is a current in the coil. Which statement explains this force of attraction?
- A** The coil of wire has its own gravitational field.
 - B** The coil of wire is made from soft iron.
 - C** The current in the coil of wire creates a magnetic field.
 - D** The current in the coil of wire induces a charge on the magnet.

- 27 A student rubs a plastic rod with a cloth.

The rod becomes positively charged.

What has happened to the rod?

- A** It has gained electrons.
B It has gained protons.
C It has lost electrons.
D It has lost protons.
- 28 Which quantity is measured in coulombs?
- A** charge
B current
C electromotive force
D power
- 29 A cylinder of conducting putty has length l , diameter d and resistance R . The putty is now moulded into a cylinder of diameter $2d$ that has the same volume.

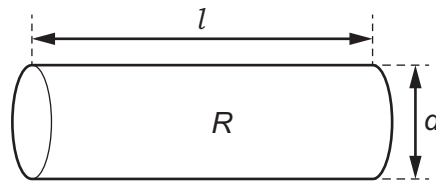

By which factor does the resistance of the putty cylinder decrease?

- A** 2 **B** 4 **C** 8 **D** 16
- 30 The average current during a lightning strike between a cloud and the ground is 1.5×10^4 A.
 The lightning releases 3.0×10^8 J of energy and lasts for 2.0×10^{-4} s.
 What is the average electromotive force (e.m.f.) between the cloud and the ground?
- A** 4.0 V **B** 100 V **C** 1.0×10^8 V **D** 9.0×10^8 V

31 A student connects a variable potential divider (potentiometer) circuit.

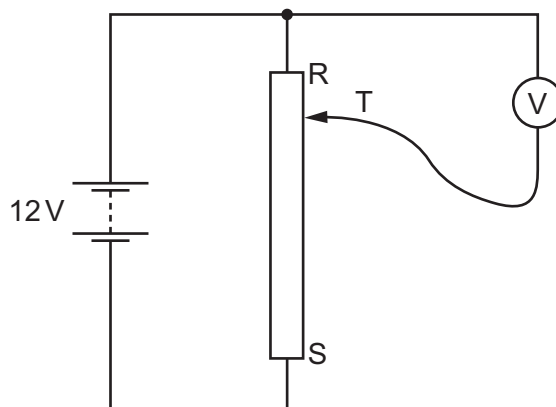

What happens to the reading on the voltmeter as the sliding terminal T is moved from R to S?

- A It decreases from 12V to 0V.
- B It increases from 0V to 12V.
- C It remains at 0V.
- D It remains at 12V.

32 The circuit diagram shows a circuit with an a.c. supply, a diode and a resistor.

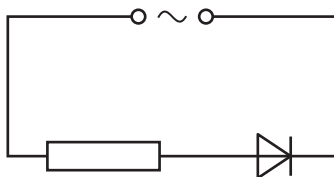

Which diagram shows how the current I in the resistor varies with time t ?

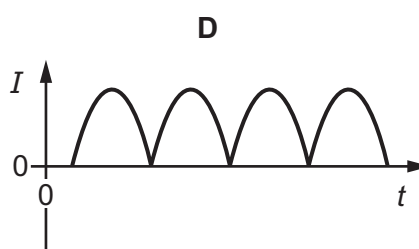
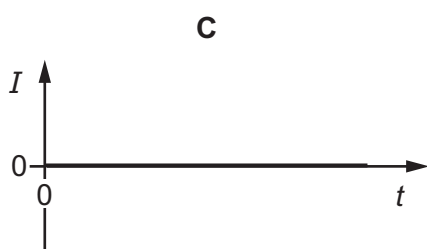
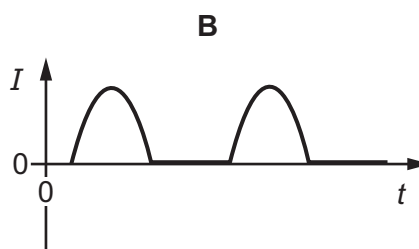
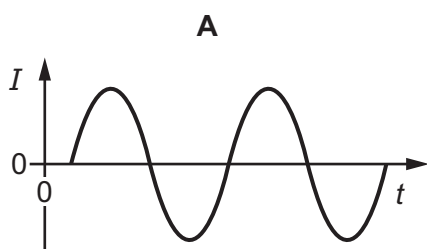

- 33 A light-dependent resistor (LDR) and a resistor R are connected in a series circuit. Light falls on the LDR.

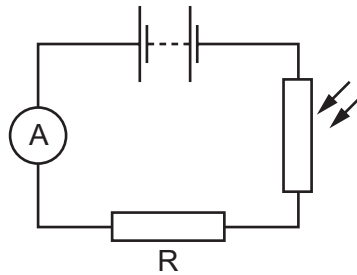

The brightness of the light falling on the LDR decreases.

What happens to the resistance of the LDR and what happens to the reading on the ammeter?

	resistance of LDR	reading on ammeter
A	decreases	decreases
B	decreases	increases
C	increases	decreases
D	increases	increases

- 34 The diagram shows a logic gate.

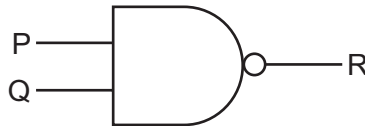

Which input combinations at P and Q gives an output of 0 at R?

	P	Q
A	0	0
B	0	1
C	1	0
D	1	1

- 35 A simple d.c. electric motor is fitted with a coil that rotates in a magnetic field. A commutator connects the power supply to the coil.

What is the purpose of the commutator?

- A** It converts a.c. into d.c. in the coil.
- B** It prevents the current from becoming too great, because the coil has a low resistance.
- C** It reverses the direction of the current in the coil after every 180° rotation of the coil.
- D** It switches the current off momentarily after every 90° rotation of the coil.
- 36 What is the purpose of a relay?
- A** to change a large voltage into a small voltage
- B** to change a small voltage into a large voltage
- C** to use a large current to switch on a small current
- D** to use a small current to switch on a large current
- 37 Which row gives the relative charge of an electron, a neutron and a proton?

	electron	neutron	proton
A	-1	0	-1
B	-1	0	+1
C	+1	-1	0
D	+1	0	+1

- 38 A nuclide of element X undergoes β -decay.

Which statement is correct?

- A** The nucleon number increases by 1.
- B** The nucleon number stays the same.
- C** The product is another nuclide of an isotope of X.
- D** The proton number decreases by 1.

39 A sample of radioactive isotope is decaying.

The nuclei of which atoms will decay first?

- A** It is impossible to know because radioactive decay is random.
- B** It is impossible to know unless the age of the material is known.
- C** The atoms near the centre will decay first because they are surrounded by more atoms.
- D** The atoms near the surface will decay first because the radiation can escape more easily.

40 A detector of ionising radiation gives a background reading of 20 counts/minute.

A radioactive isotope with a half-life of 2.0 days is brought near to the detector. The reading on the detector increases to 100 counts/minute.

How long does it take for the reading on the detector to decrease to 40 counts/minute?

- A** 2.0 days **B** 4.0 days **C** 5.0 days **D** 10 days

BLANK PAGE

Permission to reproduce items where third-party owned material protected by copyright is included has been sought and cleared where possible. Every reasonable effort has been made by the publisher (UCLES) to trace copyright holders, but if any items requiring clearance have unwittingly been included, the publisher will be pleased to make amends at the earliest possible opportunity.

To avoid the issue of disclosure of answer-related information to candidates, all copyright acknowledgements are reproduced online in the Cambridge International Examinations Copyright Acknowledgements Booklet. This is produced for each series of examinations and is freely available to download at www.cie.org.uk after the live examination series.

Cambridge International Examinations is part of the Cambridge Assessment Group. Cambridge Assessment is the brand name of University of Cambridge Local Examinations Syndicate (UCLES), which is itself a department of the University of Cambridge.